

PJUUR®

imagine invisible

PJ-TWIST-ST

TWIST FRAME-ST (PJ-TWIST-ST)

(FRAME ONLY)

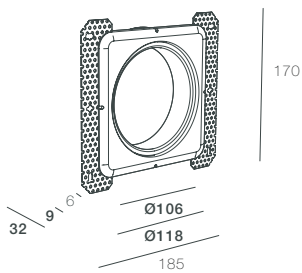

TO BE USED WITH:

TWIST White 2x230V (B)
 TWIST White 2x230V (NL)
 TWIST White 1x230V (B)/ 2x USB
 TWIST White 1x230V (NL)/ 2x USB
 TWIST - Others (Order anywhere)

1 a

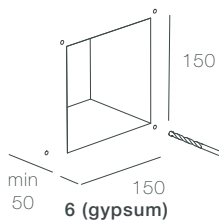

1 b

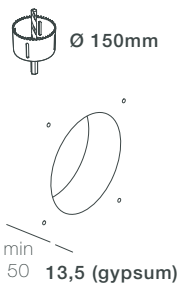

3

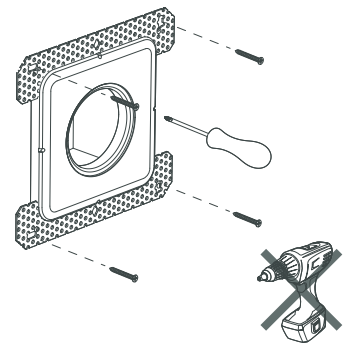

2 a

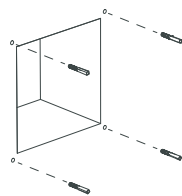

2 b

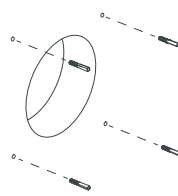

4

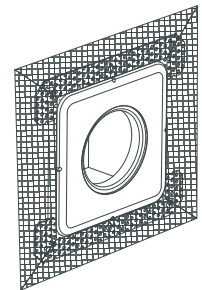

5

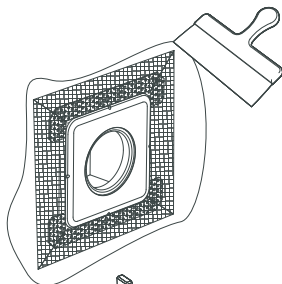

7

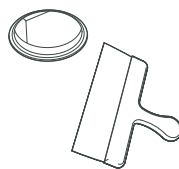

9

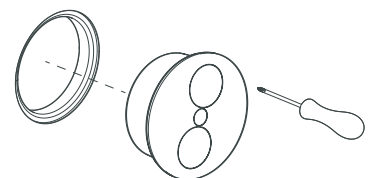

6

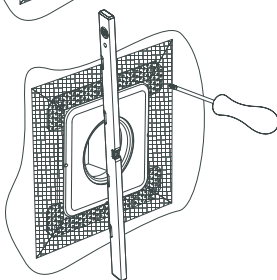

8

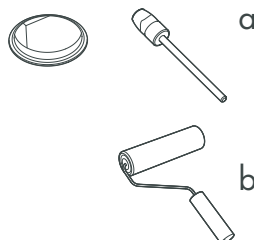

See installation manual of
TWIST-Module

PJUUR®

PJUUR®
 Heerbaan 2 (b)
 9190 Kemzeke (B)

info@pjuur.com

All models and designs are the intellectual property of PJUUR®. All models and designs are registered by copyright, (utility) model protection and/ or patent under the Benelux and European Law. PJUUR®

V4-18/03/2021

GENERAL CONDITIONS / PRODUCT LIABILITY / WARRANTY

- The products should be checked, installed, build-in, connected and tested by a certified installer.
- The products should be installed in accordance to the local regulations of buildings and electric installations.
- The products should always be installed or replaced with the necessary care.
- Do not drop, throw, ... the frames and products. Smartphones and tablets are also not designed to drop them or to be handled carelessly. The products may seem to be fragile, as they are made from reinforced plaster, but in case of negligence, damage is a result.
- Before installing: Check the frames and products on any damage and/ or inconsistencies. Damaged products may not be installed.
- Please read all instructions prior to assembly. Follow it step by step.
- Do not use machines and/or electric hand tools.
- Use a manual screwdriver: tighten the screws carefully.
- PJJUUR takes no responsibility on the final installation of the frames and/or faulty installed products.
- Turn off the power supply before installation or maintenance of the frames, the products or the installed equipment.
- Misuse of, or changes to the products shall nullify any guarantee.
- Keep children away from the products.
- Never cover the products with e.g. insulating material.
- The information, specifications and details of the products in this document are subject to change without notice; the manufacturer is free to change the design, specifications and instructions for installation.
- PJJUUR assumes no responsibility or liability for any errors, inaccuracies that may appear in this manual.
- Leave a copy of this document with person responsible for maintenance.
- This document is part of the general selling conditions of PJJUUR. The customer is supposed to know our general selling conditions.
- In case of doubt contact the manufacturer: info@pjuur.com.

READ BEFORE PLASTERING

- Finish the HW-frames like normal drywall systems.
- Finish the ST-frames like regular plaster finishing.
- Use glass fiber mesh tape on the joints.
- Only install the frames when the construction is completely windproof!
- Do not use excessive water or do not moisture the frames excessively.
- Avoid (yellow) StucPrimer on the visible part of the frames.
- The front-side of frames can be used as reference surface when plastering. Keep visible contour / edges clean at all time!
- In case of uneven ceilings or walls or when thick layer of plaster must be used:
 - First plaster the wall or ceiling and keeping the frame untouched.
 - Let it dry.
 - Check the position of the frame and fine-tune if necessary.
 - Plaster up to the border of the frame and finish.